

Holes will be found at one end of the bowl and a tapered pin attached to a chain to fit them. This is to enable the card to be pierced

and positively located in place, as in some regions birds peck at the cards and move them.

7. EVALUATION

Depending on the curved card in use, the hourly division varies in width from the top to bottom. Therefore care must be taken when measuring the length of a burn.

To help calculate the length of a trace when it has been interrupted, a template is available, M114041. Made from transparent plastic, it has two different grids printed on it, one with parallel sides at the same spacing as the hour lines on a straight card. The other grid has tapered sides with the same spacing as the hour lines on the curved recording card.

Each grid is sub-divided into 10 equal divisions as shown in Figure 6.

- Place the template over the recording card using the appropriate grid, aligning it with the hour lines.
- Count the number of divisions from the hour line to the end of the burn, one division equals 6 minutes.
- Add the length of the burns together to achieve the duration for one day.
- Alternatively take a sheet of paper.
- Lay the edge along the trace and mark its start and end points.
- Move the sheet along to the next trace.
- Align the end of the first burn with the beginning of the next and mark its length.
- Repeat this until you have noted the length of all the burns.
- Lay the edge of the paper along the sun

card the same distance from the edge as the burn.

- Starting from a convenient hour line, the total distance will give the duration of sunshine for one day. See Figure 7.

When the record has been made by a midsummer sun, the burn will spread, but in midwinter or in a haze it may only be just recognizable.

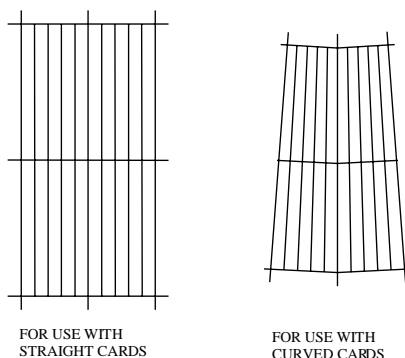

Figure 6: Grids on template M114041

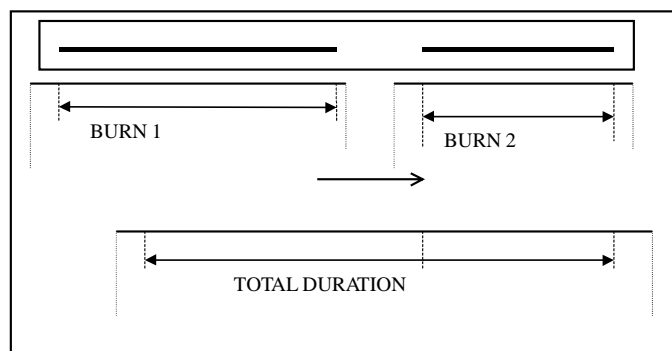

Figure 7: Total interrupted burns for one day

In the former case, the end of the burn is taken to lie halfway between the centre and the extreme edge of the curved end of the burn, but in the latter case, it should be measured from the extreme end. See Figure 8.

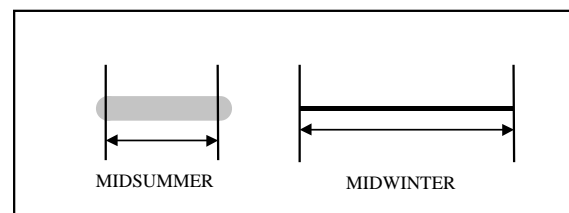

Figure 8: Where to measure burns

8. SERVICING

The instrument is virtually maintenance free, regular checks of the trace as described earlier are recommended. Keep the sphere clean using a non-scratching cloth, and remove any debris, frost from the grooves of the bowl.

CASELLA CEL's in house service department offers a comprehensive range of repair and calibration services, designed to effect a fast and efficient back up for all our products. The service department is operated under the scope of our BSI registration for products manufactured by us. We will however, undertake the repair of other manufactures equipment.

For further information please contact the service department at our Bedford headquarters. We will be happy to provide quotations for individual repairs or provide annual maintenance under contract.

CASELLA CEL LIMITED
Regent House
Wolseley Road
Kempston
Bedford
MK42 7JY
Telephone: +44 (0) 1234 844 100
Facsimile: +44 (0) 1234 841 490
E-mail: info@casella.co.uk
Webpage: http://www.casella.co.uk

9. TECHNICAL INFORMATION

9.1 Specification

Adjustment for latitude:	0 to 65° N or S after selecting correct model
Sphere:	101.6 mm dia (±1.3 mm)
Focal length for Sodium D light:	74.9 mm ±0.25 mm
Dimensions:	240 x 187 x 165 mm
Weight:	4.3 kg

9.2 Ordering Information

Tropical - for latitude 0 to 45° N or S (cards not included):	102271D
Temperate - for latitude 45 to 65° N or S (cards not included):	102270D

9.3 Accessories And Spares

One years supply of cards (BMO pattern) for use in latitudes up to 65° N or S:	M107901
200 summer cards (No 6730) long curved	
200 winter cards (No 6731) short curved	
100 equinoctial cards (No 6732) straight	
Transparent template for measuring length of trace:	M114041

ALTERATION WITHOUT NOTICE

The contents of this manual are subject to change without notice.

SUNSHINE RECORDERS CAMPBELL STOKES PATTERN



User Instructions HB3190-04

COPYRIGHT

The copyright in this document is vested in CASELLA CEL LIMITED. The contents of this document must not be used for purposes other than for which it has been supplied or reproduced or disclosed wholly or in part without the prior written permission of CASELLA CEL LIMITED.

1. INTRODUCTION

The Casella Campbell Stokes Sunshine Recorder is manufactured to a design based on British Meteorological Office (BMO) specifications. It is designed to measure the duration of visible sunshine for one day and uses the intensity of the Sun's rays to burn a trace on to a recording card.

The instrument measures only the *duration* of sunshine, for *intensity* measurements you would require a solarimeter.

The sphere is made from well-annealed optical glass and the card on which sunshine

hours are recorded is inserted into the base of the unit. Each card is marked with hourly intervals and an optional transparent plastic template is also available to help measure the curved trace more accurately.

The instrument is fully adjustable for operation at different geographical latitudes and levelling screws on the base ease installation.

Two versions of the sunshine recorder are available, depending upon latitude, please see 'Ordering Information' for more details.

2. PRINCIPLE OF OPERATION

A glass sphere is used to focus the Sun's rays to an intense spot in order to burn a trace on to a heat sensitive recording card. As the Sun moves across the sky, the spot moves across the card burning a trace, when the Sun is obscured the trace is interrupted.

The sphere is made from colourless optical glass and is clamped in a metal arc. Also attached to the arc is a metal bowl of spherical section, which is grooved on the inside to hold the recording cards. It is positioned at the correct focal length from the sphere to ensure burning of the trace.

Different instruments are available depending upon the latitude of the recording station.

- 0 - 45° North or South - Tropical
- 45 - 65° North or South - Temperate

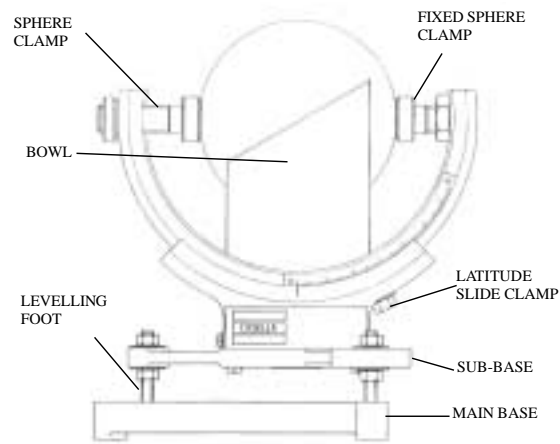

Figure 1: General arrangement of the sunshine recorder

The only difference between the versions is the shape of the bowl.

The arc is mounted on a grooved slide, which enables the bowl to be set to the latitude of the recording station.

3. RECORDING CARDS

The cards have been treated to char rather than burn and to reduce the amount they swell if they get wet.

When the Sun's altitude changes with the seasons the Sun's image travels up and down the bowl, so that three different types of sun card are required.

As the position of each card changes within the bowl, three pairs of overlapping grooves have been cut on the inside of the bowl. The grooves overlap so that the burn does not run close to the edge of the recording card before the next seasonal card.

Figure 2 shows the position of each of the seasonal cards within the bowl.

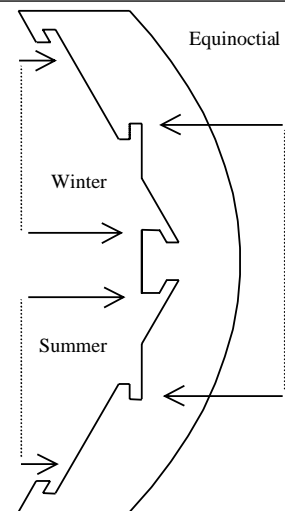

Figure 2: Position of sun cards in the bowl

4. INSTALLATION

4.1 Access to Sun Rays

The Sun's rays must have unobstructed access to the instrument in all seasons and at all times of the day. Due to the low intensity of the Sun's rays at sunrise and sunset, the only exceptions are obstacles whose height does not exceed 3° above the horizon.

Because of the need for unobstructed sunlight, the roof of a building is often a convenient site. However, if the building is too high, it is possible for the roof to obscure the Sun's rays after Sunrise and before

Sunset, thus preventing the measurement of a full days sunshine.

4.2 Mounting

The instrument should be mounted on to a rigid warp free surface at a convenient height to read and change sun cards, e.g. on a brick pillar, with a wooden top.

Point the instrument in a southerly (northerly) direction, within $\pm 10^\circ$ and secure the main base to the mounting surface usually wood (25 cm square).

5. ADJUSTMENT

5.1 Levelling

This is achieved by adjusting the bottom nuts (below the sub-base of the instrument) and using a spirit level.

- Slacken the nuts above and below the sub base. See Figure 3.
- Level using the bottom nuts.
- First level in an East / West direction.

To help levelling, set the latitude to 0° for Tropical or 52° for Temperate installations, then lay the spirit level across the bowl.

- Then level in a North / South direction,

placing the spirit level on the flat machined part of the sub-base.

- When you have levelled the instrument, tighten the top nuts finger tight.

If the instrument is not level in an East / West direction the trace will burn at an angle across the card.

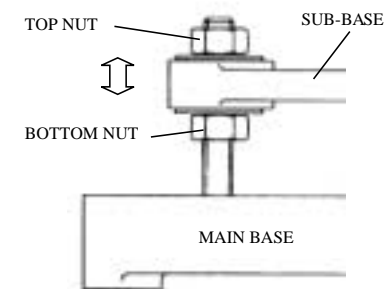

Figure 3: The Sub-base

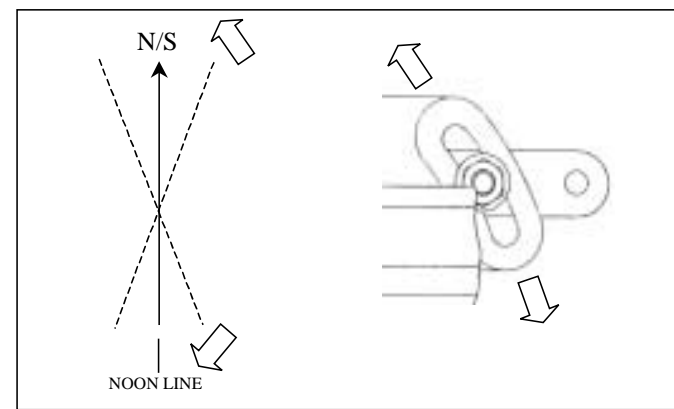

Figure 4: Rotation of the sub-base for North / South orientation

5.2 North South Orientation

Using the mid-point (noon line) on the bowl, align the instrument to face due South in the Northern Hemisphere and due North in the Southern.

- Adjust the instrument by rotating the sub-base.

If using a compass remember to take magnetic variation into consideration. See Figure 4.

- When aligned, tighten up the top nuts.

You can also use time to set the instrument. For example at 12 p.m. (G.M.T), 0° longitude, the Sun's image will fall on the bowl's noon line when pointing due South.

For other longitudes local noon times need to be calculated.

5.3 Setting the Latitude

The bowl must be set to the correct latitude for the station.

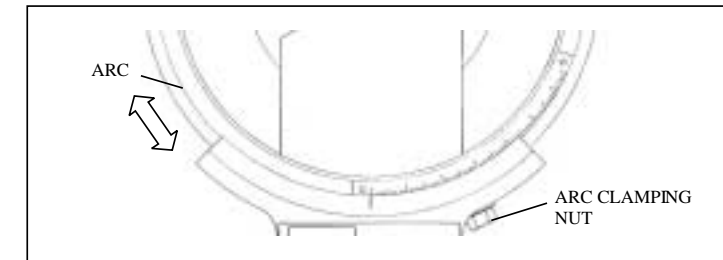

Figure 5: Position of the arc clamping nut

6. DAILY ADJUSTMENT

Where possible, the cards should be changed after sunset so that each card has a record of one day's sunshine. If this is not possible care must be taken with the dates, to keep each day's sunshine correct.

When inserting a new card make sure that the noon line on the card lines up with the noon mark on the bowl.

On the back of each card, date ranges are given for when they are to be used in both the Northern and Southern hemispheres as well as spaces for date etc. At certain latitudes it is necessary to trim the cards to the specified dotted line. This ensures that the Sun's rays are not obscured by the edge of the card at Sunrise and Sunset.

Difficulty may be experienced in removing the recording card from the bowl when wet. Do not try to force the card as it may tear. With a

- Undo the nut beneath the arc support, using the tommy bar provided.

- Set the latitude by aligning the engraved latitude marks with the arrowhead.

- Tighten the nut while making sure that the arc does not slip. See Figure 5.

5.4 Fitting the Sphere

The sphere is clamped into the arc using two knurled head screws.

One of these screws is locked into position at the factory, so when the sphere is clamped in place it is already correctly aligned.

sharp blade cut as close to the grooves as possible, parallel to the length of the card. The remaining card in the groove can be removed with a pointed stick or other soft material.

The glass sphere should be kept clean using a chamois leather or other non-scratching material. It is also important to keep the grooves clean and to remove any snow or frost immediately.

When changing the cards, note the position and angle of the burn, if it has not run parallel to the edge of the card, the instrument should be adjusted. Occasionally while the Sun is shining, check to see that the burn is being produced at the correct time and adjust if necessary.

The instrument can be upset only by someone moving it and not during normal use.